

# LEAF

design  
SERGIO BELLIN



SitLand®

# COMFORT DESIGNED TO RESPECT THE ENVIRONMENT

Leaf is the seat that improves your day. Breathable and ergonomic, Leaf ensures comfort, reducing fatigue. A product characterised by innovative colours and materials, that easily adapts to any functional and aesthetic need: always respecting the environment.



## THE AESTHETICS OF COMFORT

Leaf is conceived as functional and aesthetically pleasant chair. The back in polyamide is characterised by an elegant leaf pattern, embossed on the back. The back upholstery instead, consists of a particular technical padding made in fabric combined to a highly-elastic expanded elastomer, perfectly adherent to the user, ensuring comfort. The back technical padding is characterised by two different geometric patterns obtained through thermo-moulding. The air chamber created between the back structure and padding confers instead optimal breathability.

## TAILOR-MADE TO YOUR NEEDS

Leaf features a lumbar support adjustable in height and depth. A spring system allows in fact to adapt the seat to the support needs of its user. The lumbar support ensures proper support at the base of the spine, reducing fatigue due to extended sitting times.

## THE MECHANICS OF COMFORT

Leaf features a synchro mechanism that regulates the seat and back angle, locking it in 5 positions with anti-shock system. The tilt tension can be adjusted by a practical side handle, according to the user's weight.

## ASSISTED MOVEMENTS

Leaf seat moves in tune with its user. Adjustable in depth and lockable in the desired position, Leaf seat follows the user's movements in the "free" option activated with the second locking position of the adjusting lever.

## COMFORTABLE

Leaf comfort is also guaranteed by the wide and thick seat (75mm) with pad in flexible polyurethane. The side stitching of the upholstery enhance the seat silhouette.

## FREEDOM TO CHOOSE

Different types of armrests, bases and casters offer the possibility to choose the most suitable version for your needs.

## MODELS AND DIMENSIONS

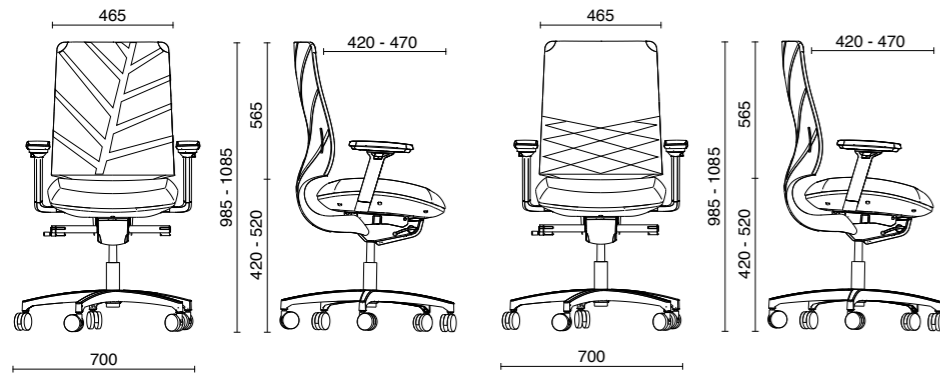

Operative with an elegant LEAF pattern embossed

Operative with a "DIAMOND-SHAPE" pattern in the lower part

## MECHANISM

	LEAF	LEAF START&GO
Synchronized mechanism for the adjustment of back and seat angle, lockable in 5 positions with anti-shock system adjustment of the tension of the body-weight using a side handle	<input type="checkbox"/>	<input type="checkbox"/>
Seat height adjustment gas lift.	<input type="checkbox"/>	<input type="checkbox"/>

## ARMS

 Pair of 4D armrests, adjustable in height and in width. Polished aluminium support, top in soft black polyurethane, adjustable in depth and pivoting.

 4D arms, adjustable in height and in width, black soft-touch top, pivoting left/right and adjustable in depth. Black support.

 4D arms, adjustable in height and in width, black soft-touch top, pivoting left/right and adjustable in depth. Light grey support.

 2D arms, adjustable in height and in width, soft-touch top.

 Pair of 2D armrests adjustable in height and in width. Support in light grey (RAL 7035) polyamide, fixed black top in PU soft polyurethane.

 Pair of 2D armrests adjustable in height and in width. Support in black polyamide, fixed black top in PU soft polyurethane.

## BASES



High resistance 5-star base in light grey (Ral 7035) nylon with strengthening steel ring, ø 700 mm.





High resistance 5-star base in black nylon with strengthening steel ring, ø 700 mm.





5-star die-cast aluminium base, polished, ø 700 mm.

## CASTERS

 Self-braking rubber casters ø 50 mm for hard floors, black structure.

 Free casters ø 50 mm, black structure.

 Self-braking casters ø 50 mm, black structure.

 Free casters, ø 65 mm for soft floors.

 Self-braking rubber casters, ø 65 mm for hard floors.

 Hollow free and rubber casters, ø 65 mm for hard floors, black structure.

 Hollow free and rubber casters, ø 65 mm for hard floors, chromed structure.

## COLOURS, MATERIALS, FINISHING \*

### PLASTIC FINISHING

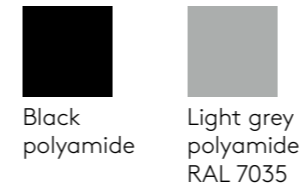

### SEAT UPHOLSTERY



### TECHNICAL BACK UPHOLSTERY



\* Please refer to the Price list in force and to the General sale conditions for the colours and the combinations available for every single product. Colours shown are used for reference only and may look different in reality. Please contact SitLand to receive more information.

## PCON.PLANNER



It is possible to configure our model Leaf by using pCon.planner program for the design of 2D and 3D environment.

pCon.planner allows to design working solutions in a fast and intuitive way, creating "realistic" images with advanced features, with a considerable saving of time and resources.

It is easy to start using pCon.planner: after downloading the software in the proper page, it is possible to download pCon.catalog, the practical online catalogue of products ready to be set up according to anyone's need, and then include the products in the projects.

For more information on the use of pCon.planner and the access to the products of the SitLand's catalogues, please contact [com@sitland.com](mailto:com@sitland.com)

## D.Lgs. 81/2008

Leaf comply with the Italian norm D.Lgs. 81/2008.

## GS MARK

Leaf complies with Geprüfte Sicherheit or GS.



The **Geprüfte Sicherheit** or GS mark is a certification mark for technical equipment. Its presence indicates that the equipment complies with the German and European safety requirements and in particular that it is free from harmful substances, safe to breaking risks.

The GS mark is known around the world and integrates a number of specific European directives for the product and ensures that the instruction manual is correct and complete.

The tests performed are:



## GREENGUARD CERTIFICATION



Leaf has achieved GREENGUARD Certification.

GREENGUARD e GREENGUARD Gold are products' certifications released after accurate laboratory tests which assure a low level of chemical emissions of the GREENGUARD tested products in the inner environments. As a matter of fact, in the inner environments, the air is 2 - 5 times more polluted than on the outside and the pollutants come from products and materials that we use every day. Therefore, the quality of air in the inner spaces is an important issue when people pass the most part of their time in inner environments.

The products certified GREENGUARD ensure a low level of chemical emissions, therefore a better quality of air in those places where they are used. Those chairs which obtained the GREENGUARD Gold certification grant the total absence of chemical emissions, then they are the safest choice for public spaces like schools and healthcare setting. The products certified GREENGUARD contribute to create Leed buildings.

For more information on GREENGUARD, visit the official web site [ul.com/gg](http://ul.com/gg).

## UNI EN 1335 CERTIFICATION

Leaf comply with the norm UNI EN 1335-3.

The work conditions and the protection of the people at work, as far as safety and health are concerned, provide that "the office chairs" are produced according to the ergonomic principles and the functionality requirements contained in the following norms:

- UNI EN 1335-1, dimensions and definitions of the dimensions;
- UNI EN 1335-2, safety requirements;
- UNI EN 1335-3, test procedures for the safety.

The chairs are classified in three different classes according to their specific performance and dimensional characteristics:

- Class A considers the more restrictive dimensional requirements and mostly respect the anthropometric dimensions from 5 to 95% of the population.
- Class B considers the middle requirements among the classes, respecting the minimum requirements requested by D.Lgs. 81/2008.
- Class C considers the minimum requirements.

For more information, please contact SitLand's customer service at [service@sitland.com](mailto:service@sitland.com)

## WARRANTY



Leaf has 5 years warranty. For any further detail, please contact SitLand's customer service at [service@sitland.com](mailto:service@sitland.com)

## MORE INFORMATION

Please look through our catalogue to see all the different versions available of Leaf

[http://www.sitland.com/sitland\\_catalogues/sitland\\_general\\_catalogue/sitland\\_general\\_catalogue.html#p=106](http://www.sitland.com/sitland_catalogues/sitland_general_catalogue/sitland_general_catalogue.html#p=106)

or see our Leaf page into our web site [www.sitland.com](http://www.sitland.com)



# SitLand®

SitLand S.p.A.  
Via Cà Silvestre, 52  
36024 Nanto - Vicenza  
info@sitland.com - www.sitland.com  
Tel. +39 0444 637100



SitLand S.p.A. is certified  
UNI EN ISO 9001: 2008  
UNI EN ISO 14001: 2004

Follow us on:

