

# Wilkhahn



IN. 184 range.



## Activating. Concentrating. Relaxing.

To activate our bodies and minds, concentrate better and relax more effectively it's vital to bring back a diverse and frequent range of motion to offices. Which is why, as dynamic sitting specialists, we taught office chair ON to "walk" for the first time. We came up with and patented a world first, Trimension® technology. It encourages your hips to move and securely maintains your body's centre of gravity whatever posture you adopt.

For our latest office-chair range IN, our engineers have succeeded in adapting Trimension® for the upper medium-price category. More compact, more straightforward and even more dynamic, IN offers a unique combination of natural, three dimensional sitting dynamics with superb comfort and a feeling of well-being. The synchronously flexible seat and back react to the slightest shifts in weight and follow your body in any direction, just like a second skin. But IN's not just impressive from a technical point of view. Created by wiege design company, its design is also outstanding. Distinctive pivotal points and a young athletic aesthetic make it a high-quality eye-catcher that's understated at the same time.







# IN. 184 range. Technical details.

# Wilkhahn

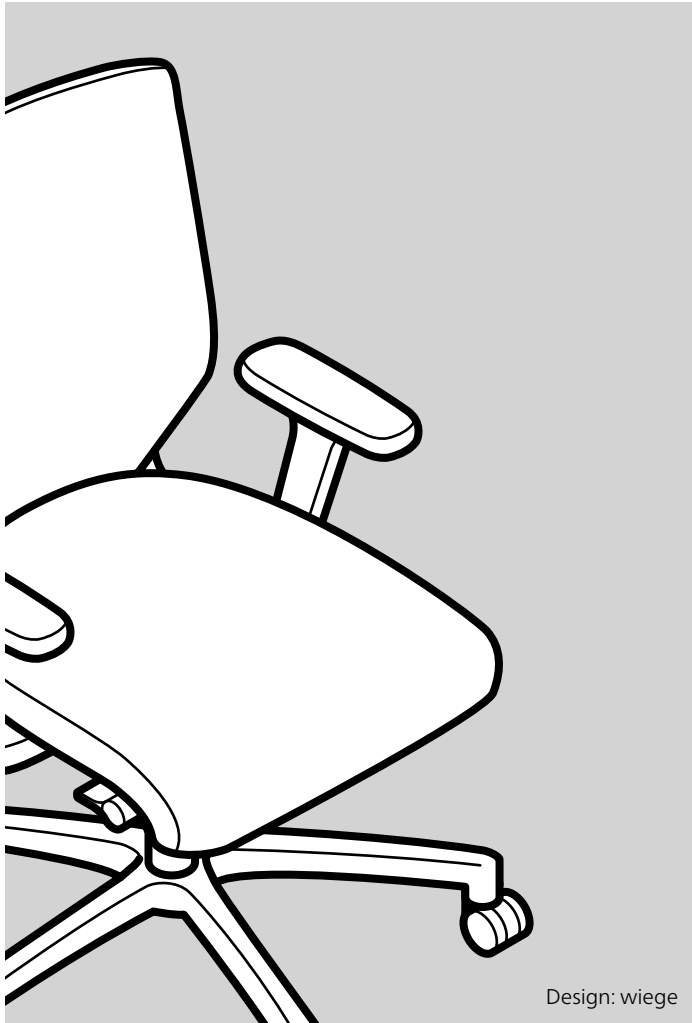

Design: wiege

## Function

An office task chair with Trimension®, integrated synchronously supporting 3D kinematics which allows the right-hand and left-hand half of the chair to be tilted in any direction via two swivel arms that can move separately from one another. The goal is to encourage the natural range of motion the pelvis is capable of which includes flexing, extending and tilting it sideways to rotating it. The combination of the 3D synchronous adjustment mechanism with a highly elastic seat and back guarantees the chair adapts automatically to any movement made or posture adopted by the person sitting on it. As a result, the body is supported in any position and maintains its centre of gravity.

The counter pressure, which provides support in any direction moved in, is infinitely adjustable for people weighing from 45 to 140 kg by regulating the central spring. The backrest has optional, height-adjustable lumbar support (in six lockable positions of up to 60 mm).

The backrest and seat can be locked in the neutral sitting position, the 3D frontwards tilt of 5° can be activated by pressing a button in order to harness the maximum range of motion. The seat height is infinitely adjustable at the touch of a button between 400 mm and 520 mm with a DIN 4550-compliant gas lift. Seat depth: 430 mm, optionally with seat depth that can be adjust-

ed while sitting down in 4 lockable positions of 400 to 450 mm.

## Frame

Five-star base made of black through-dyed, glass fibre-reinforced polyamide, optionally die-cast aluminium, coated, polished or high-lustre polished.

Twin-wheel swivel castors with load-dependent braking, made of black polypropylene compliant with DIN EN 12529 as the standard version for carpets, optionally with grey polyurethane facing for hard floors. Antistatic castors on request.

Gas lift covered by telescopic protective tube made of black through-dyed polypropylene. Mechanism cover made of die-cast aluminium, coated matt black with black through-dyed polypropylene bellows and thermoplastic elastomer to accommodate the flexibly mounted central spring, knob to adjust the counter pressure made of polyamide (for people weighing from 45 to 140 kg).

Each chair has two swivel arms which can move independently of one another, made of die-cast aluminium, coated, polished or high-lustre polished, with protective caps made of polypropylene.

## Seat and back

Unitary, highly elastic and flexibly suspended seat and back made of high-tech polyamide. Seat shell made of black through-dyed polyamide with polypropylene seat upholstery panel.

Polyurethane seat cushions with CFC-free foam, covered in Racer, optionally also with form-fit knit (Formstrick) that offers different support zones, in the same material as the backrest cover, or with fabric covers from the Wilkhahn fabric collection, then with facings sewn-in and deep top stitching lengthways to create contours. The seat upholstery panel, cushioning and covers are replaceable.

All models optionally available with seat-depth adjustment of 400 to 450 mm. Seat cushions covered with form-fit knit (Formstrick) which has different support zones, in the same material as the cover on the backrest, or with fabric covers and then with facing made of black Racer sewn in, only in the same material and colour when the seat cover is also in Racer and with deep, lengthways top stitching to create contours. The seat upholstery panel, cushioning and covers are replaceable.

The back section is the frame, optionally with Hytre!® lumbar support, the height of which can be adjusted by 60 mm in six lockable positions and which is retrofittable at any time. The back is covered in form-fit knit (Formstrick) which includes different elasticity for flexible and supporting zones, optional two-ply cover made of form-fit knit (Formstrick) with integrated foam with different support zones. Colours based on the Wilkhahn sample card.

## Armrests

Armrests adjustable in height by 100 mm in ten lockable positions and made of glass fibre-reinforced, black through-dyed polyamide, optionally with three dimensional adjustment. Armrest pads made of black through-dyed polypropylene, optionally of polypropylene foam. Optional: also available without armrests.

## Standards

Office chair standard DIN EN 1335, American standard ANSI/BIFMA X 5.1. and for "Ergonomics tested" certification.



Subject to change.

You can find our text modules for tenders in our [media center](#)

# IN. 184 range. Product types.

Wilkhahn



Model 184/7 task chair, medium-height backrest, on castors

# IN. 184 range. Upholstered types.

# Wilkhahn



Seat with Formstrick (form-fit knit) cover



Seat with Racer cover



Backrest with single-ply Formstrick



Backrest with double-ply Formstrick



Seat with alternative Wilkhahn covers (with side facings)



Seat with alternative Wilkhahn covers, with short top stitching to create contours when optional seat-depth extension is chosen (with side facings)

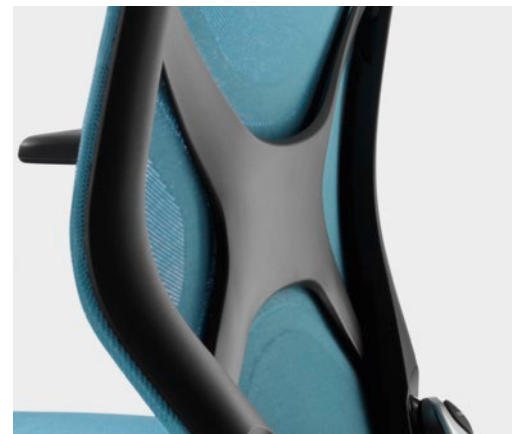

Backrest with single-ply Formstrick, with lumbar support



Backrest with double-ply Formstrick, with lumbar support



# IN. 184 range. Frame versions.

Wilkhahn



52 Aluminium polished



72 High-lustre polished aluminium

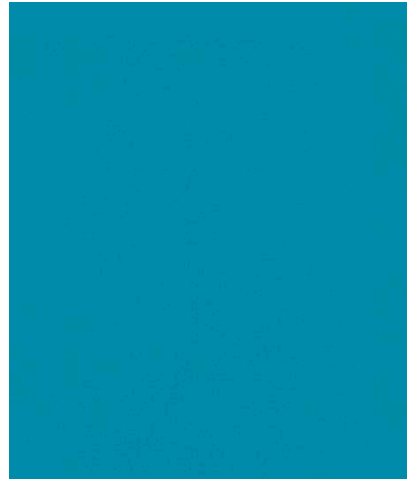

81 Matt turquoise, RAL 230 60 30



82 Matt grey, RAL 7040



Plastic star base (black star base)



60 Matt silver satin RAL 9006

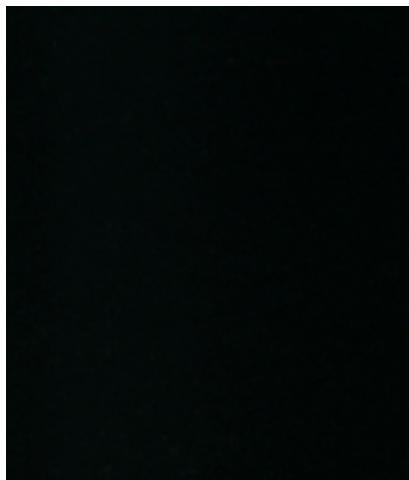

80 Matt black RAL 9005



83 Matt orange, RAL2001



84 Red matt, RAL 3003

IN. 184 range. Upholstery material 37 Racer and 41 Formstrick.

Wilkhahn

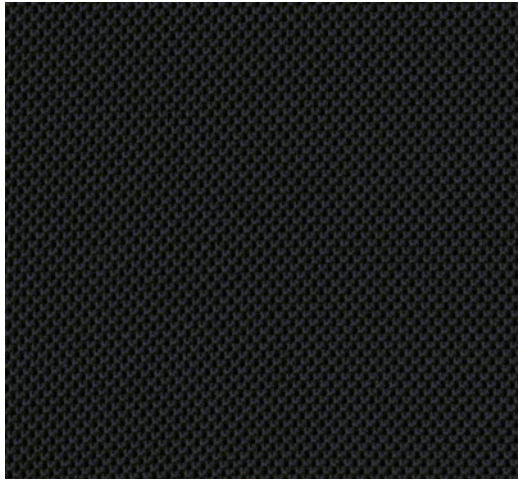

Racer 37-25/Formstrick 41-25

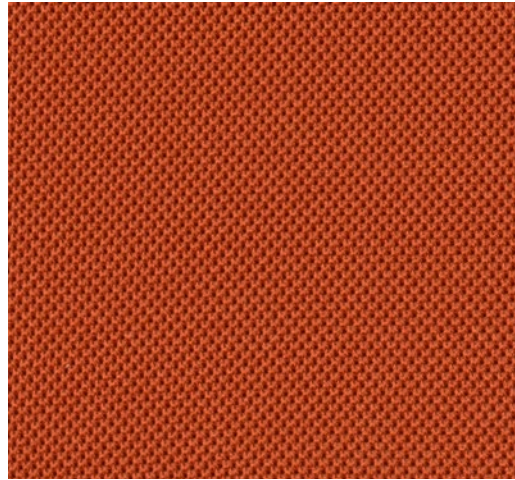

Racer 37-34/Formstrick 41-34

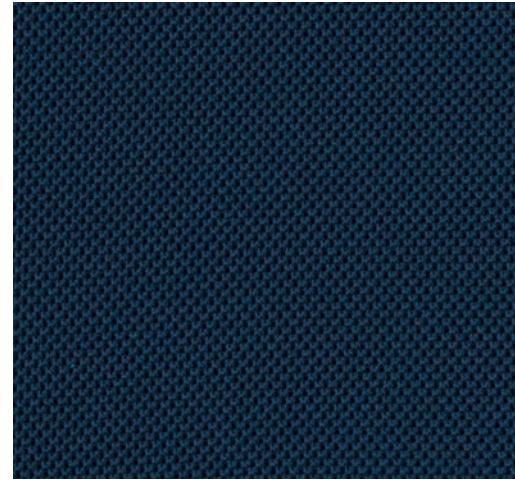

Racer 37-57/Formstrick 41-57

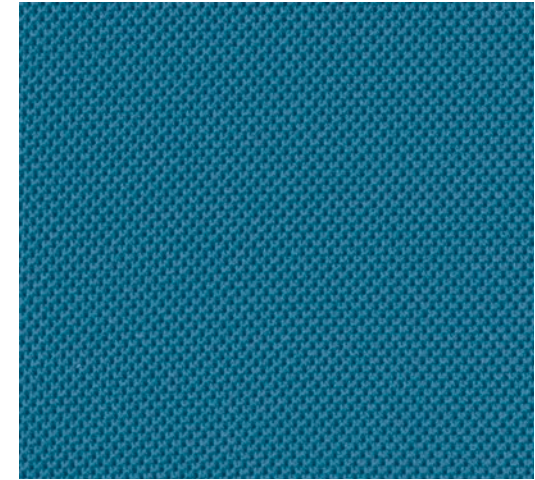

Racer 37-63/Formstrick 41-63

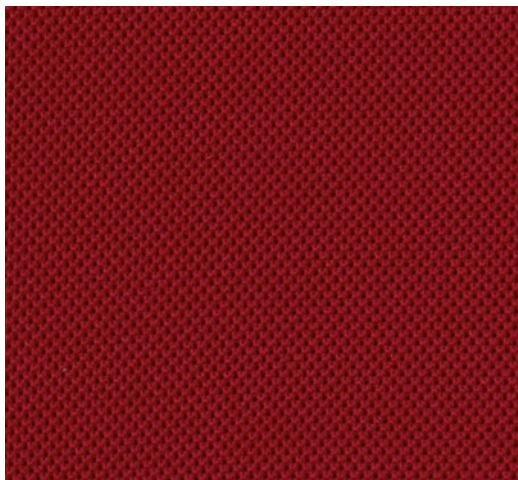

Racer 37-89/Formstrick 41-89

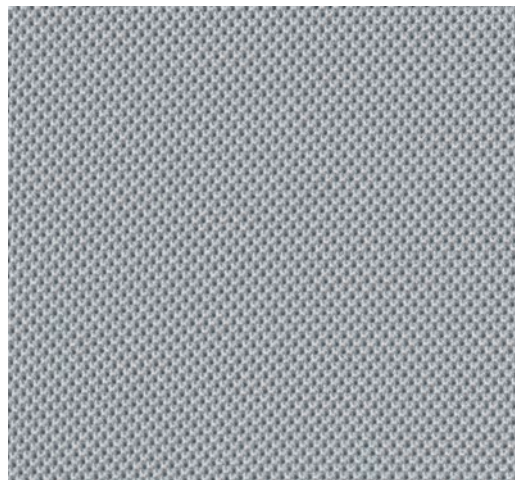

Racer 37-95/Formstrick 41-95

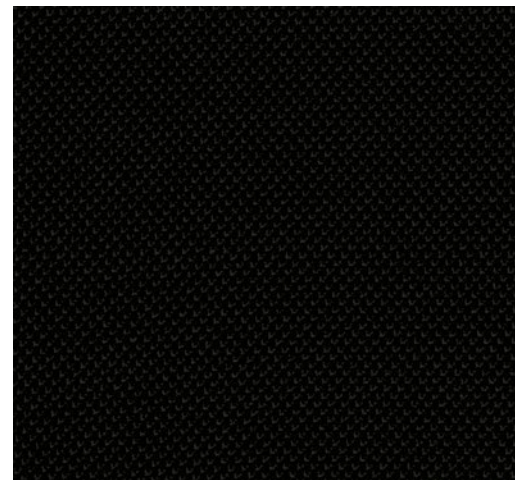

Racer 37-99/Formstrick 41-99

Pictures Racer, material colour-matched Formstrick

# IN. 184 range. Models and dimensions.

Wilkhahn

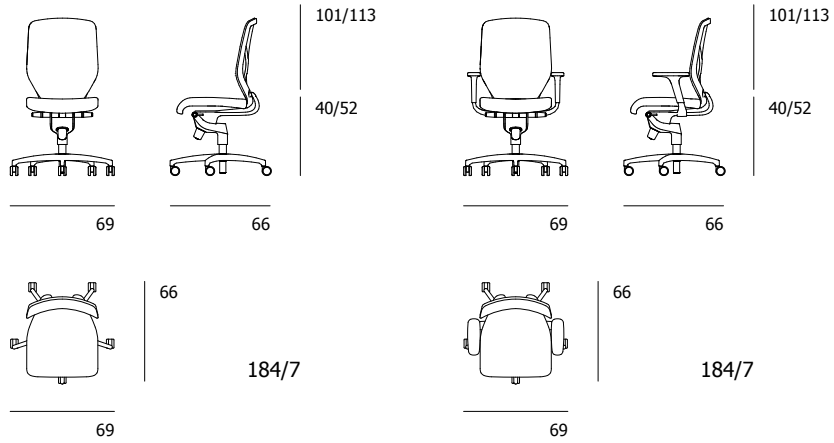

# IN. 184 range. Models and dimensions.

Wilkhahn

Trimension® lies at the heart of IN. This integrated, synchro-supporting 3D kinematics allows the right and left-hand sides of the seat to lean in any direction via two swivel arms that move independently of one another. The goal is to activate the natural range of motion that our pelvises are capable of by flexing, extending, leaning sideways or rotating them. With its patented Trimension®. Wilkhahn has taught seating to walk. This kinematics offers a type of dynamic seating which is exceptional to date and which mirrors the way people's joints naturally work. Two sliding joints close to the knees and two socket joints near the hips are connected via the swivel arms just like thighs. The range of motion includes synchronous leaning backwards and forwards from  $-12^\circ$  to  $0^\circ$ , or includes activating an opening angle of up to  $5^\circ$  in the seat and an up to  $26^\circ$  tilt in the back. At the same time, the seat and back can be tilted sideways from the horizontal by up to  $13^\circ$ . The counter pressure provides support in any direction and infinite adjustment of the elasticity allows it to adapt to people weighing between 45 to 140 kg.

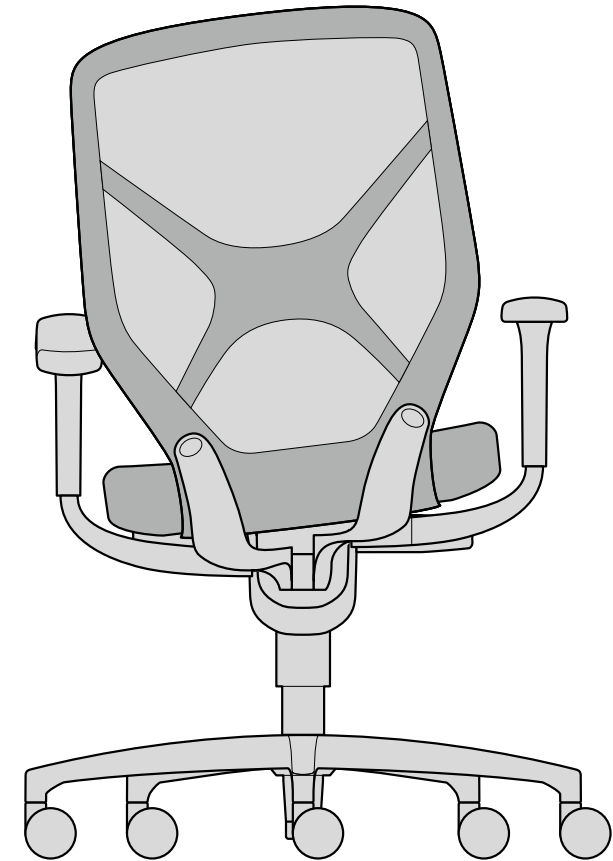
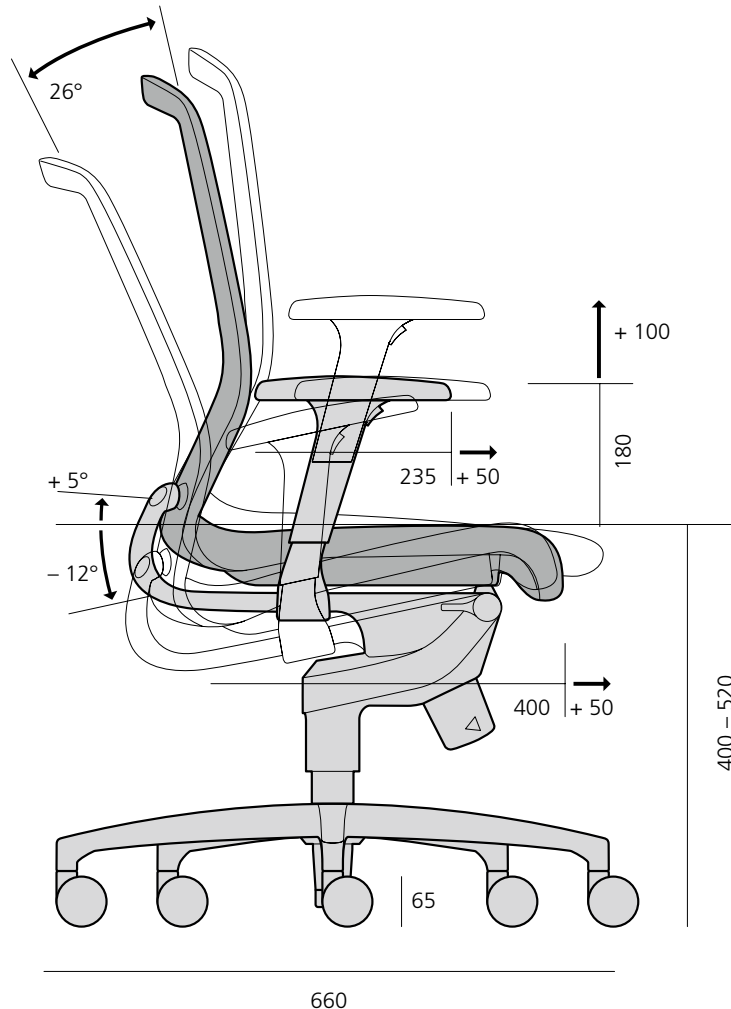

All dimensions in mm.  
Subject to change.

# IN. 184 range. Awards / standards / certificates.

# Wilkhahn

## Awards



reddot award 2015  
winner



contract

## Product certificates / product standards

Office chair standard DIN EN 1335, American standard ANSI/BIFMA X 5.1. and for "Ergonomics tested" certification. Safety certificate (LGA Nuremberg).



Not all certificates / standards apply to all types.

You can find our text modules for tenders in our [media center](#).

## Company's certificates



## Environment and product

### Sustainability included.

Just like its big brother ON, where Trimension® was used for the first time, IN has also been designed to provide the best in form and function. It's also made to last. Its dynamic 3D seating concept, enhanced added value due to its health-giving benefits, first-class materials and superb craftsmanship make it an excellent choice. Its modular and service-friendly design make replacing expendable parts, covers and upholstery easier and extends its useful life. The chair does of course come with CFC-free foam cushions and eco-friendly materials. Wherever technically possible, we've used materials that can be recycled. Each part is labelled so that it can be properly recycled. As a result, in the simplest version, up to 94% of IN can be recycled or up to 93% where the superior version is concerned.

- The materials marry extreme precision with robust stability. The star bases consist optionally of die-cast aluminium, or through-dyed, glass fibre-reinforced reinforced polyamide and the swing plates of die-cast aluminium. The flexible seat shell and backrest frame are made of high-performance polyamide and the armrest of glass fibre-reinforced polyamide. The mechanism housing is made of die-cast aluminium with bellows to accommodate the flexibly mounted central spring made of black through-dyed polypropylene and thermoplastic elastomer. All aluminium and polypropylene components comprise a maximum of recycled materials and can be fully recycled.
- The seat cushions are made of CFC-free covered polyurethane. With seat upholstery panels they can also be replaced, alongside the cushioning and covers.
- The adjustment and motion functions are simplicity itself and offer ease of use. Consequently, if a chair wears out it can be easily repaired or parts retrofitted to extend its useful life.

The worldwide new standard in three-dimensional dynamic seating is equally straightforward and high quality. Due to its smart design the number of parts has been reduced. The integrated multiple functions are eco-friendly and offer excellent value.

You can find our environmental product information in our [media center](#).

# IN. 184 range. Accessories and other items.

# Wilkhahn



Trimension® with front tilt



Seat-depth extension



Seat-depth extension



Additional height-adjustable lumbar support



Without armrests



Anti-static castors



2D armrests  
3D armrests

Further accessories not pictured:  
armrest pads made of polyurethane foam for 2D and 3D armrests